

GSM/GPRS/GPS PORTABLE VEHICLE TRACER GPS104 User manual



Preface

Thank you for purchasing the tracker. This manual shows how to operate the device smoothly and correctly. Make sure to read this manual carefully before using this product. Please note that specification and information are subject to changes without prior notice in this manual.

Any change will be integrated in the latest release. The manufacturer assumes no responsibility for any errors or omissions in this document.

Contents

I.	Introduction.....	2
	1. Main Features.....	2
	2. Applications.....	2
	3. Hardware Description.....	2
	4. Accessories.....	4
	5. Specifications.....	5
II.	Installation and operating.....	5
	1. Production installation.....	5
	2. SIM card installation.....	6
	3. Battery Charging.....	6
III.	Basic functions.....	7
	1. ON/OFF Function.....	7
	2. Initialization.....	7
	3. Change Password.....	7
	4. Add and Delete authorization.....	7
	6. Successive Locating Automatically.....	8
	7. Get Absolute address including street name.....	8
	8. Check the Vehicle State.....	9
	9. Check IMEI.....	9
	10. Setup time zone for tracker.....	9
	11. Track Mode.....	9
	12. Monitor mode.....	9
	13. Cut off the Oil and Power System(Optional).....	10
	14. Resume the Oil and Power System(Optional).....	10
	15. Tracker's Hardware Resetting.....	10
IV.	Alarm Function and settings.....	10
	1. Geo-fence.....	10
	2. Movement Alarm.....	10
	3. Over Speed Alarm.....	11
	4. Shock Sensor Alarm.....	11
	5. SOS(Optional).....	11
	6. Low power alarm.....	11
V.	GPRS Setting.....	12
	1. Setting up APN.....	12
	2. GPRS User Name and password Setup.....	12
	3. IP and Port Setup.....	12
	4. Modes Switch between "SMS" and "GPRS".....	12
	5. GPRS Tracking & monitoring platform.....	12
VI.	Sleep Function.....	13
VII.	Cautions.....	13
VIII.	Simple Faults & the Solutions.....	13
IX.	LED indicator status.....	14

I. Introduction

This tracker is a new product based on the GSM / GPRS network and GPS satellite positioning system, which set multiple functions of security, positioning, monitoring surveillance, emergency alarms and tracking in its entirety. It can track and monitor remote target by SMS or internet.

1. Main Features

1.1 Waterproof shell

1.2 Built-in large capacity 6000MA battery, long standby time of 60 days.

1.3 Powerful magnets to absorb to vehicle firmly.

1.4 Real-time tracking, retrieve of lost vehicles, cargo.

1.5 Movement alarm, Geo-fence alarm, shock sensor alarm, remote monitoring.

1.6 Support map viewing on mobile phone screen, get absolute address by SMS, GPRS real time tracking on web based server.

1.7 Built-in high sensitivity GPS and GSM antenna to make it can be used alone without installation, convenient and quick.

1.8 Support for external GSM antenna, GPS antenna, and external power supply for the tracker to be installed on the device which can provide power for long-term using.

2. Applications

Applies to: Locating and tracking service for cars, trucks, container trucks, special vehicles, cargo and criminal investigation officer.

3. Hardware Description

3.1 Front face

Built-in GSM antenna



Built-in GPS antenna

3.2 Rear fac

Built-in powerful magnet



3.3 Side face



LED Indicator

EXT. GPS antenna

EXT. GSM antenna

SIM Slot



3.4 Side face



EXT. Power, Relay

USB



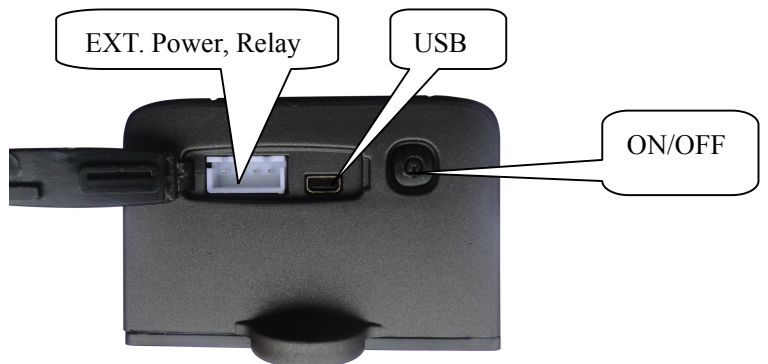

ON/OFF



3.5 Side face

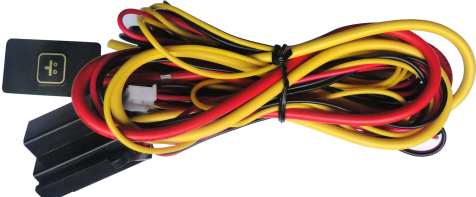

4. Accessories

No.	Pictures	Name	Specs
1		AC Adapter	Input: AC 100-240V, Output DC: 1.5A, 12V
2		Lighter car adapter	Car 12V OR 24V power
3		GPS Antenna	3 meters
4		GSM Antenna	2 meters
5		Harness	4PIN (OPTIONAL)

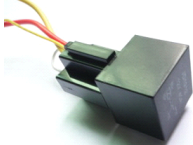
6		Relay	12V/40A OR 24V/40A depends on the vehicle type (OPTIONAL)
---	---	-------	---

5. Specifications

Content	specifications	
DIM.	94mm*60mm*38mm	
Weight	300g	
Network	GSM/GPRS	
Band	850/900/1800/1900Mhz or 900/1800/1900Mhz	
GSM/GPRS Module	Simcom340z or Simcom300z	
GPS Module	SIRF3 chip	
GPS sensitivity	-159dBm	
GPS Accuracy	5m	
GPS Start time	Cold status	45s
	Hot status	1s
EXT. power	DC 12 V -24V	
Operating Current	Sleep Current	4mA±1mA
	GSM operating Current	54mA±3mA
	GPRS Current(data transfer)	60mA±5mA
Battery	3.7V 6000mA/h Polymer battery	
Charge current	1.2A±0.2A	
Charge time	5h	
Standby time	GSM sleep mode	1500h
Storage Temp.	-40°C to +85°C	
Operation Temp.	-20°C to +65°C	
Humidity	5%--95% non-condensing	

II. Installation and operating

1. Production installation

- 1.1 The product is easy to install. The built-in powerful magnet can make it to be directly adsorbed on the iron objects.
- 1.2 Built-in GPS and GSM antenna, external antenna can be an optional.
- 1.3 The tracker is waterproof, but please still avoids the long-term placement in the places of water infiltration.
- 1.4 If you need an external power supply, cut oil & power system and SOS feature, Please find 4PIN main wire (if optional), wiring diagram is as follows:

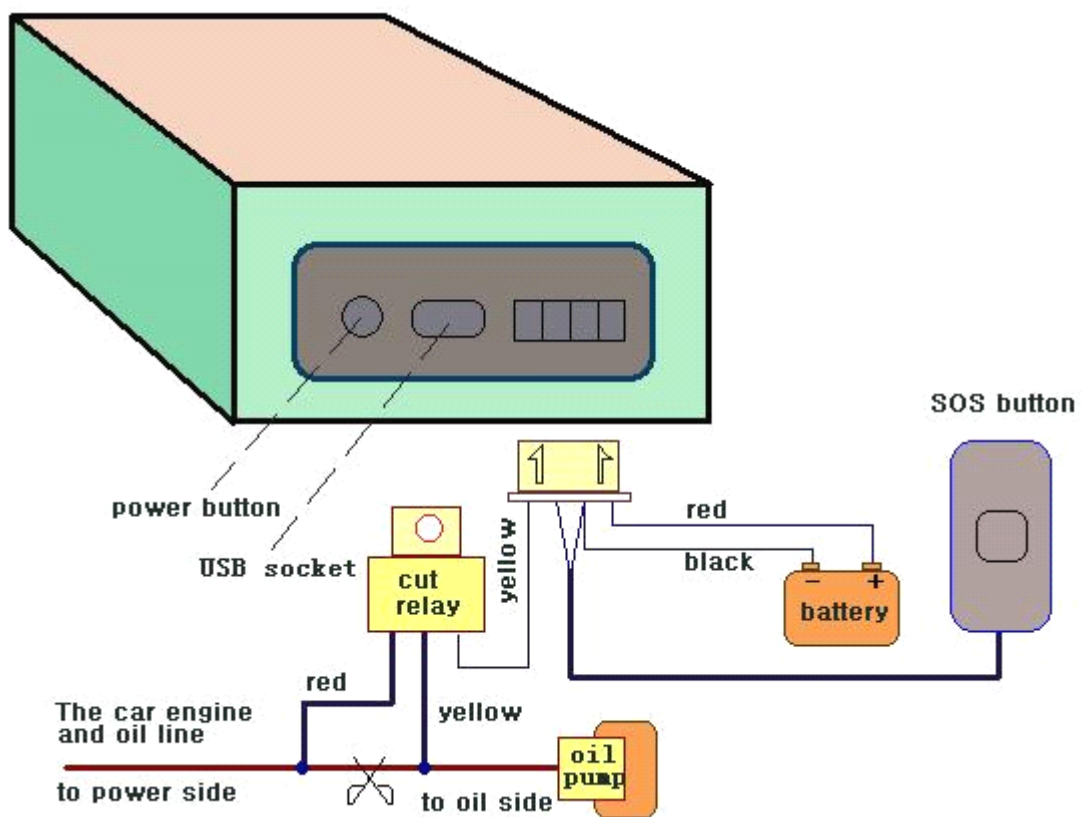

Note: Please install SOS button on the hidden place driver can touch.

2. SIM card installation

- 2.1 Open the waterproof sealant, use tweezers or pointed objects to touch the SIM card switch lightly, the SIM card slot will pop up, and install the SIM card correctly, and then put the SIM card slot back.
- 2.2 Please make sure that the SIM card is GSM network and able to execute the function of incoming calls display, no calls can be diverted and the PIN code is locked. The SMS

format must be TXT format, and can't recognize the PDU format.

3. Battery Charging

Please fully charge the product for the first use and charge as following:

3.1 Home charge, find the AC adapter from the accessories and connect 4-PIN plug into 4-PIN socket, and then connect the other end to mains supply.

3.2 Car charge, find the car lighter charger from the accessories and connect to car cigarette lighter.

Note: The tracker is being charged if the LED is red constantly during the charge, and charging is finished when the LED change from red to green, and then you can stop charging.

III. Basic functions

Note: You don't need to type "+" for all the command in this manual, "space" means press the space button on the cell phone keyboard.

1. ON/OFF Function

1.1 In the OFF state, press the ON/OFF switch for 3 seconds, then the three LED will bright flash 1 time, which means the tracker had been switched on.

1.2 In the ON state, press the ON/OFF switch for 3 seconds, then the three LED will bright flash 2 times, which means the tracker had been switched off.

2. Initialization

Send SMS "begin+password" to tracker from you cell phone, it will reply "begin ok" and return to the default factory settings state. (Default password is: 123456). For example: Send SMS "begin123456" to tracker, it will reply "begin ok".

3. Change Password

Send SMS "password+old password+space+new password" to the tracker from you cell phone to change the password. For example: Send SMS "password123456 888888" to tracker, it will reply "password OK", and it means the password has changed successfully. And please keep the new password in mind.

Note: The new password must be 6 digits, or the tracker can't recognize.

4. Add and Delete authorization

4.1 Authorization phone number is the phone number you used for tracking, controlling, alarms, etc, and only 5 phone numbers to be allowed to authorized in the tracker at most. Add authorization as following two ways:

4.2 For the first authorization, Call and track the tracker device for 10 times from cell phone in success, it will make the cell phone number as the authorized number automatically, and reply “add master ok”.

4.3 Authorization: Send SMS “admin+password+space+cell phone number” to set up an authorized number, the other authorized numbers should be set by the first authorized number, if the number is successfully authorized, the unit will reply” admin OK” .

If you need to track the target tracker device when it enters into another country, you must add the country code before the cell phone number, for example, send SMS” admin123456 008613322221111” to the device. Note: 13322221111 will be set up as the authorized number.

4.4 Delete authorization: Send SMS “nadmin+password+space+authorized number” to delete the authorized number.

5. Single Locating

Any number call the tracker device, it will reply a SMS including the position of latitude and longitude if don't set up the authorized number. If authorized number has set successfully, the device won't reply SMS including the positioning of latitude and longitude when the unauthorized number dials up it. Dialing the tracker device from the authorized number, it will hang up your calling and respond to a real-time latitude and longitude information as following:



When GPS signals lost, The SMS including the position of latitude and longitude is the positioning that the tracker received GPS signals at last. It may be different with its exact current location, so pay attention to the time included in the SMS.

6. Successive Locating Automatically

6.1 Limited intervals and times tracking: Send SMS “fix+intervals+time unit+tracking times+n+password” to tracker. For example: Send SMS “fix030s005n+password” to tracker, it means tracker will send GPS coordinates each 30 seconds for 5 times. The intervals and tracking times must be in 3 digits and the maximum value is 255, the interval must be not less than 20s. Time unit is (s: second, m: minute, h: hour).

6.2 Non-limited continuously tracking: Send SMS “fix+intervals+time unit+***n+password”, For example “fix030s***n+password”, it means tracker will send GPS coordinates each

30 seconds continuously.

6.3 Cancel automatically locating: Send SMS “nofix+password” to tracker.

7. Get Absolute address including street name

You must set up the APN of your local GSM network for the SIM card in tracker first before using this function, if your local GSM network need user name and password for gprs , please setup according to the GPRS instructions in chapter V. Send SMS “address+password” to tracker after setup APN, tracker will reply detailed absolute address including street name.

8. Check the Vehicle State.

Send SMS “check+password” to tracker to check charge status, battery status, GPS status, GSM reception status. For example, send SMS “check123456” to tracker, and the tracker will reply following information after execute the SMS command:

Power: Power off /charging/charge finish

Battery: 100%

GPS: OK/NO GPS

GSM Signal: 1-32 (The higher digit it shows; the stronger of GSM signals it receives.)

9. Check IMEI

Send SMS "imei+password" to the unit. For example, Send SMS "imei123456" to the tracker device, an IMEI number in 15 digits will reply to your cell phone.

10. Setup time zone for tracker

Send SMS “time+space+zone+password+space+time” to the tracker unit, If succeed, It will reply “time OK”. For example: Send SMS “time zone123456 8”, 8 is Chinese time zone, If your country time zone is minus, send SMS “time zone123456 -8”.

11. Track Mode

Dial the tracker to get GPS coordinates once, track mode is the factory default mode.

Setup: Send SMS "tracker+password" to tracker, it will reply "tracker ok" and change to track mode.

12. Monitor mode

12.1 Dial the tracker to monitor the voice around it.

12.2 Setup: Send SMS "monitor+password" to tracker, it will reply "monitor ok!" and change to monitor mode.

12.3 If you want to quit the mode, please change to track mode.

13. Cut off the Oil and Power System(Optional)

Send SMS "stop+password" to the tracker device, it will reply "Stop engine Succeed" to your cell phone from the tracker device, and stop your car engine as well, at the same time. It will remain the immobile state until receiving the next SMS command of resuming the oil and power once receiving SMS command to cut off the oil and power system.

14. Resume the Oil and Power System(Optional)

Send SMS "resume+password" to the unit, It will reply "Resume engine Succeed" and resume your car engine as well, at the same time. It will remain this state until receiving the next SMS command to cut off the oil and power system once receiving SMS command to resume the oil and gas system.

15. Tracker's Hardware Resetting

Send SMS "reset+password" to tracker device to reset the GSM module and GPS module of the tracker device, it will reply "reset ok".

IV. Alarm Function and settings

All the alarms will be send to all the authorized phone numbers once the alarms are triggered in SMS mode, if the tracker keep in triggered status and alarms are not be canceled, tracker will keep sending alarms to authorized phone numbers every 3 minutes. If tracker works in GPRS mode instead of SMS mode, tracker will send alarms to web based online system.

1. Geo-fence

1.1 Set up a geo-fence for the tracker device to restrict its movements within a district. The unit will send SMS to the authorized numbers when it goes out of this district.
Set up: When the unit stays immobile in a place for 3-10 minutes, the user can send SMS "stockade+password+space+latitude,longitude;latitude,longitude" to unit to set the restricted district. In case of breach, it will send SMS "stockade!+geo-info" to the authorized numbers. Tracker will stop sending alarm if tracker returns to the fence after geo-fence triggered

1.2 Cancel: Send SMS “nostockade+password” to deactivate this function.

2. Movement Alarm

Movement alarm refers to the alarm which will be triggered if tracker device move beyond a certain distance. (Default distance is 200 meters.)

Setup: when the unit stays immobile in a place for 3-10 minutes, the user can send SMS “move+password” to the tracker device. It will reply “move ok!”. In case of breach, movement alarm will be triggered, and tracker will send SMS “Move” along with a Geo-info to the authorized numbers.

Cancel: Send SMS “nomove+password” to deactivate the movement alarm.

3. Over Speed Alarm

3.1 Over speed alarm will be triggered when tracker exceed the speed you setup.

Setup: Send SMS “speed+password+space+speed” to tracker device and it will reply “speed ok!”, it means you have set up over speed alarm successfully. For example: “speed123456 080” 080 refers to 80km/h, when tracker’s speed exceed 80km/h, tracker will send SMS “speed+080!+ Geo-info” to authorized numbers.

3.2 Cancel: Send SMS “nospeed+password” to deactivate the over speed alarm.

Note: Speed must be in 3 digits, it is recommended that the speed alarm is set at not less than 30km/h. For below that rate, it may cause the excursion of the GPS signal influenced by clouds etc.

4. Shock Sensor Alarm

Setup: Shock sensor alarm is deactivated in default settings. If this function is needed, please send SMS “shock+password” to tracker device, and tracker will reply “Shock is activated!”, it means shock sensor alarm has set up successfully. When the tracker was shocked, it will send SMS “Sensor alarm+Geo-info” to authorized numbers.

Cancel: Send SMS “noshock+password” to deactivate shock sensor alarm.

Note: tracker will send alarm once for each shock, and it stop sending alarm if it isn't shocked.

5. SOS(Optional)

Long Press the SOS button for 3 seconds, the tracker device will send SMS “help me!+lat./long. to all the authorized numbers in 3 minutes interval. It will stop sending SMS “help me” when received a reply from any one of the authorized numbers.

6. Low power alarm

When the battery capacity is below 15%, tracker will send SMS “low battery+lat./long information to the authorized numbers. And it will stop sending alarms if external power is connected to charge.

V. GPRS Setting

User must send SMS via cell phone to set up APN, IP and port before starting tracking by GPRS. Please setup according to following steps

1. Setting up APN

Send SMS “APN+password+space+APN”, the tracker will reply “APN OK” if succeeded. For example: Send SMS “APN123456 cmnet”.

Note: cmnet is the APN of china GSM network, the APN varies with different GSM network operator in different countries, please check with your local GPRS network operator to get the correct APN.

2. GPRS User Name and password Setup

In most countries, the user name and password involving GPRS login are not compulsorily necessary, therefore, the entry can be skipped. For those countries requiring user name and password, please configure as following:

Send SMS “up+password+space+user+space+password”, If succeeded, tracker will reply “user, password ok!”, for example: send SMS “up123456 jonnes 666666”

Note: 123456 is password of tracker, jonnes is the user name for GPRS login, 666666 is the password for GPRS login.

3. IP and Port Setup

Send SMS “adminip+password+space+IP+space+port”, tracker will reply “adminip ok” if succeed. For example: send SMS “adminip123456 202.105.135.50 9000”, tracker will reply “adminip ok” if succeed.

Note: 123456 is the password of tracker, and 202.105.135.50 is the ip, 9000 is the port.

4. Modes Switch between “SMS” and “GPRS”

4.1 The default mode is “SMS”.

4.2 Send SMS “GPRS+password” to the unit, and it will reply “GPRS ok!” it means tracker device has switched to “GPRS” mode.

4.3 Send SMS “SMS+password” to the unit, it will reply “SMS ok!” and restore to “SMS” mode.

5. GPRS Tracking & monitoring platform

We offer a variety of real-time tracking & monitoring software platform

- 5.1 View map on the cell phone screen
- 5.2 Get absolute address in SMS by cell phone
- 5.3 PC installation GPRS tracking & monitoring software
- 5.4 Web based GPRS real time online tracking
- 5.5 Please check the CD with the tracker for detailed instructions. **【software user manual】**

VI. Sleep Function

Sleep can save power to extend the standby time, tracker will sleep as following:

1. In the absence of movement, geo-fence, over speed alarm, Successive Locating Automatically and charging, without any trigger events, and tracker will fall sleep in 5 minutes if tracker get normal GPS signals and doesn't work in GPRS mode. All the LED will off during the sleep.
2. Wake up, if any alarms was triggered including shock, incoming calling, SMS, keyboard pressing, the tracker will wake up to work as normal.

VII. Cautions

1. Don't put the unit in overheated or overcooled places.
2. Handle carefully. Don't vibrate or shake it violently.
3. Clear the unit with a piece of dry cloth. Don't clean in chemicals, detergent.
4. Don't paint the unit, this may cause some foreign materials left in between the parts.
5. Don't disassemble or refit the unit.。
6. Please read the user manual carefully before installation and operation, learn something more about the voltage range. Otherwise, it won't work properly or destroy the product.

VIII. Simple Faults & the Solutions

Faults	Analyze	Solution
Fail to turn on	1.Press the ON/OFF too short 2.Battery power is low	1.Long press 3 seconds to turn on 2. Connect with charger
NO GSM signals	1.GSM Antenna is not connect well 2. SIM card is not properly placed	1.Check GSM antenna connection 2. check SIMCARD installation or change SIMCARD.

Hang up Fail	In existence of an authorized number, an unauthorized number dials up the unit.	Please delete the authorized number or initialize the unit.
Monitor Fail	In existence of an authorized number, an unauthorized number dials up the unit.	Please delete the authorized number or initialize the unit.
GPS Fix Fail	1. GPS reception is poor. 2. GPS antenna is not connected well.	1. Put GPS in an open area 2. Check connection of GPS antenna
GPRS Connecting Fail	1. APN, IP address and port may be wrong. 2. GPRS is not active yet 3. No credit for the SIMCARD	1, Configure APN, IP and port again. 2, Active GPRS 3, Topped up the SIMCARD.

IX. LED indicator status

LED Indicator	Status	
Power LED (Red & Green light)	Green LED flash	Normal
	Red LED flash	Low power
	Red LED is on constantly	Charging
	Green LED is on constantly	Charging finished
GSM LED (Green)	OFF	searching for GSM network
	Flash fast, 1S/times	GSM Mode
	Flash slow, 3S/times	GPRS Mode
GPS LED (Blue)	Flash	No GPS reception
	ON	Good GPS reception